

## Canaletta in PE-HD SKIP 100/80 NEW

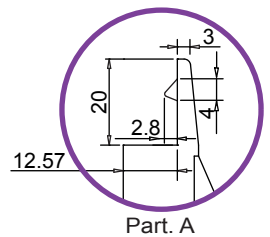
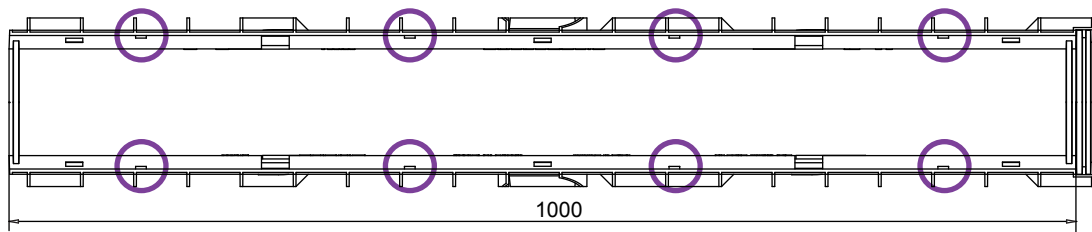
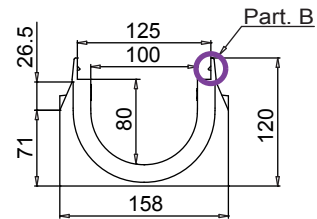
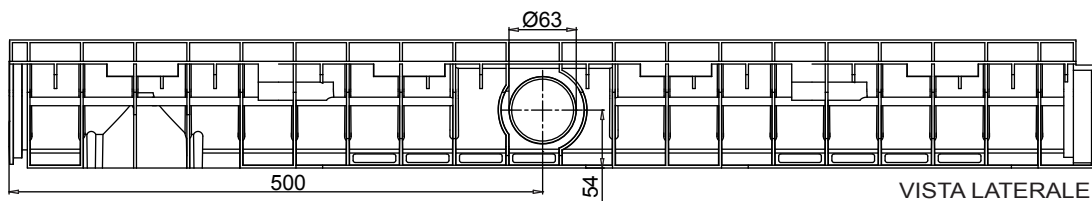
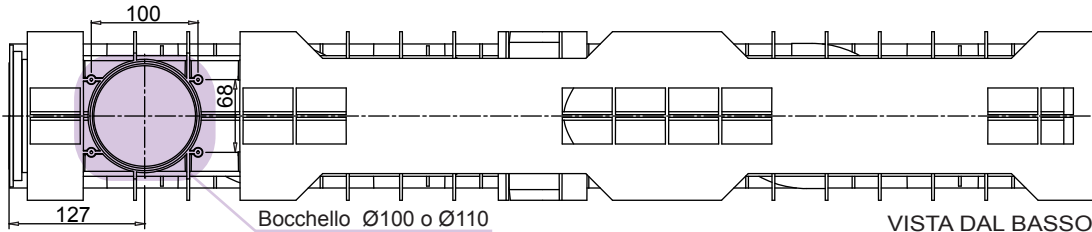

### Novità.

1. Le nuove canalette MUFLEDRAIN possono raccordarsi tra loro anche con le griglie/coperture già fissate, diminuendo notevolmente i tempi di posa.
2. Le nuove canalette MUFLEDRAIN dispongono di innovativi sistemi di fissaggio, quali "dentini" in (PE-HD) nella parete interna e l'inedita "clip" di aggancio/sgancio rapido: per un veloce e sicuro montaggio delle griglie.
3. La superficie interna, oltre a garantire un coefficiente di scabrezza elevato, non presenta alcun foro che la metta in comunicazione con l'esterno evitando così punti di infiltrazione per l'acqua.

Tenuta all'acqua: per assicurare la tenuta stagna delle canalette, si consiglia l'utilizzo di un adesivo sigillante bituminoso. A garanzia completa e duratura dell'assenza di perdite attraverso i giunti delle canalette, si può provvedere alla saldatura a caldo dei giunti stessi.

## Scheda tecnica

### Dimensioni e caratteristiche

NB: Le dimensioni ed i pesi sono soggetti alle normali tolleranze di fabbricazione

|                                         |                           |
|-----------------------------------------|---------------------------|
| Lunghezza (mm)                          | 1000                      |
| Larghezza esterna (mm)                  | 158                       |
| Altezza esterna (mm)                    | 120                       |
| Luce interna (mm)                       | 100                       |
| Altezza interna (mm)                    | 80                        |
| Scarichi                                | 1 x Ø100*/Ø110* e 2 x Ø63 |
| Materiale                               | PE-HD                     |
| Peso (Kg)                               | 1.75                      |
| Sezione di drenaggio (cm <sup>2</sup> ) | 69.28                     |
| Capacità (dm <sup>3</sup> = litri)      | 6.92                      |

\*Per ottenere lo scarico occorre utilizzare il Kit Bocchello con uscita (disponibile nelle due versioni da Ø100 o Ø110).

## Channel in PE-HD SKIP 100/80

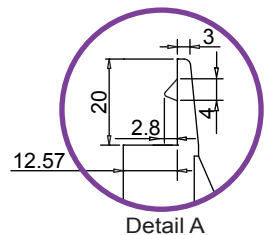
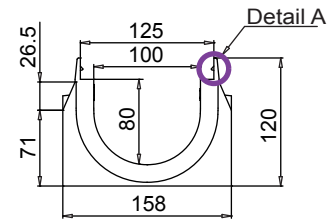
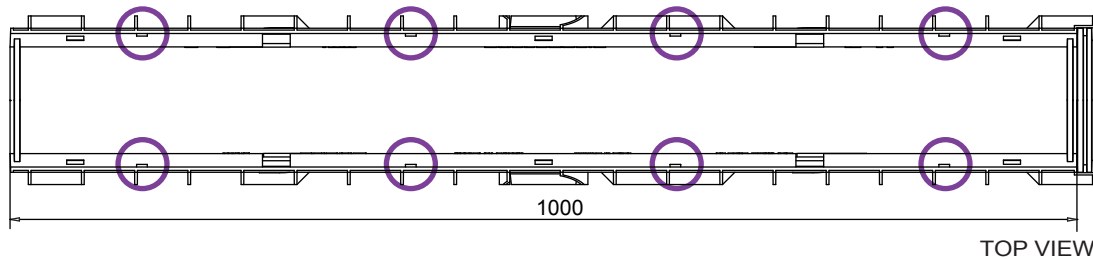
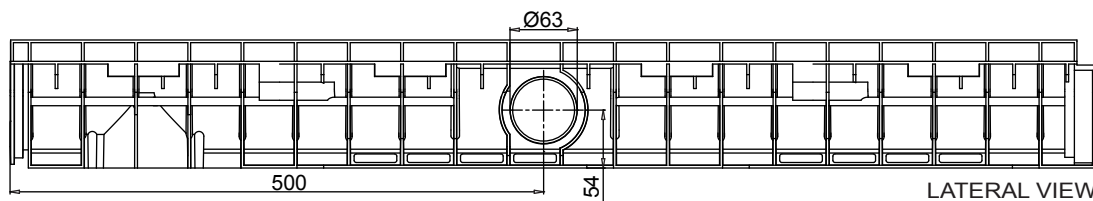
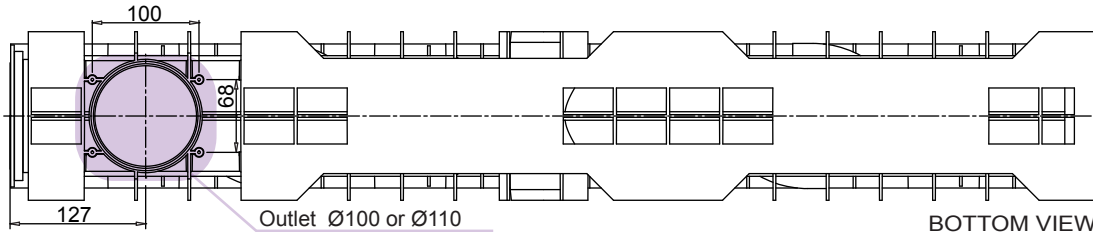

### New.

1. The new mufledrain channels can also be joined together with the gratings/covers already installed on in order to reduce installation times.
2. The new mufledrain channels have new fixing-to-channels systems, as the inner side HD-PE pins and the unreleased quick fasten clips, for an easy and safe gratings installation.
3. The inner surface guarantees an high roughness index and do not have any external passing hole in order to avoid and water infiltration.

Watertight: To ensure the watertight of the channels, it is advisable to use an adhesive bituminous sealing. As a complete and long lasting guarantee of absence of leakages through the joints of the channels, it is possible to hot-solder the joints

## Data Sheet

### Dimensions and features

N.B. Dimensions and weights are subjected to the normal tolerances of the manufacturing

|                                     |                           |
|-------------------------------------|---------------------------|
| Length (mm)                         | 1000                      |
| External width (mm)                 | 158                       |
| External high (mm)                  | 120                       |
| Internal width (mm)                 | 100                       |
| Internal high (mm)                  | 80                        |
| Outlets                             | 1 x Ø100*/Ø110* - 2 x Ø63 |
| Material                            | HD-PE                     |
| Weight (Kg)                         | 1.75                      |
| Drainage section (cm <sup>2</sup> ) | 69.28                     |
| Capacity (dm <sup>3</sup> = litres) | 6.92                      |

\*For drainage purposes use the drain gate with outlet kit (available in two versions Ø100 and Ø110).

## Fixing for Channel HD-PE SKIP 100/80

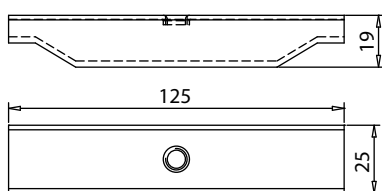

**Tie-Rod**

Code Galvanized 500412  
Code Stainless Steel 500413  
Code Black Galvanized 500414

rev. 00

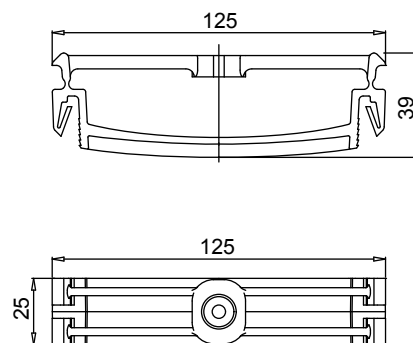

**Clip Nylon**

Code 510206

rev. 00



Assembling with Tie-Rod



Assembling with Clip Nylon

### Gratings

Slotted  
Mesh 33x33  
Mesh 33x1  
Mesh  
Slot 20 mm  
Slot 6 mm  
Mesh  
Slot 7 mm

### Materials

galvanized, stainless steel  
galvanized, stainless steel  
galvanized, stainless steel  
ductile iron  
ductile iron  
ductile iron  
HD-PE  
HD-PE

### Class

A15  
A15-B125  
A15-B125  
B125-C250  
C250  
C250  
\*\*\*  
\*\*\*

### Fixing

Tie-Rod/Clip  
Tie-Rod  
Tie-Rod  
Tie-Rod/No Fixing  
Tie-Rod/No Fixing  
Tie-Rod/No Fixing  
Tie-Rod/Clip/No Fixing  
Tie-Rod/Clip/No Fixing